

# PN4

## Snap-action Microswitches

Standard Plastic

### PN4

- Characteristics
- Precision switching with exceptional repeat accuracy
  - Wide selection of actuators
  - Panel or side mounted variants
  - Screw terminals, able to accept heavy duty wiring
  - Stepped base for maximum creepage distance

Rating Up to 250 VAC, 15 A

Dimensions (mm) 49 × 25 × 18

Actuator Plunger, long overtravel plunger, 3 spring plungers, 2 plain levers, reverse action plain lever, 2 roller levers

Approvals UL, cUL, CSA



### Preferred Range

Ordering Reference	Actuating Force (N)	Actuating Force (ozf)	Sealing	Operating pos. (mm)	Operating pos. (in)	Terminal	Circuit	Actuator	Contacts	Electrical rating
PN401	3.8	13.7	IP40	16.0	0.63	Screw/washer	CO	Plunger	Silver	Up to 250 VAC, 15 A
PN4D2	3.8	13.7	IP40	22.2	0.87	Screw/washer	CO	Spring plunger	Silver	Up to 250 VAC, 15 A
PN4K152	0.3	1.08	IP40	25.0	1.00	Screw/washer	CO	Plain lever (length 152 mm, 6.0 in)	Silver	Up to 250 VAC, 15 A
PN4K63	0.9	3.2	IP40	19.0	0.75	Screw/washer	CO	Plain lever (length 63.5 mm, 2.5 in)	Silver	Up to 250 VAC, 15 A
PN4KZ56	1.5	5.4	IP40	8.5	0.33	Screw/washer	CO	Reverse action plain lever	Silver	Up to 250 VAC, 15 A
PN4GK48	1.1	4.0	IP40	30.2	1.19	Screw/washer	CO	Roller lever (length 48 mm, 1.87 in)	Silver	Up to 250 VAC, 15 A
PN4GK26	1.7	6.1	IP40	30.2	1.19	Screw/washer	CO	Roller lever (length 26.7 mm, 1.05 in)	Silver	Up to 250 VAC, 15 A
PN41	3.8	13.7	IP40	21.8	0.86	Screw/washer	CO	Long overtravel plunger	Silver	Up to 250 VAC, 15 A
PN4G	3.8	13.7	IP40	33.3	1.31	Screw/washer	CO	Spring plunger, in-line roller	Silver	Up to 250 VAC, 15 A
PN4GH	3.8	13.7	IP40	33.3	1.31	Screw/washer	CO	Spring plunger, across-line roller	Silver	Up to 250 VAC, 15 A

### Specifications

Housing	Crastin
Plunger	Crastin
Mechanism	Snap-action, single pole
Functions	Change-over
Contacts	Silver
Terminals	Screw terminals with cup washers
Temperature range °C	-10°C to +85°C
Mechanical life	10 <sup>6</sup> cycles minimum (impact free actuation)
Protection	IP 40 (enclosure)
Mounting	Side or panel mounting
Actuators	Plain levers - zinc-plated mild steel. Roller levers - zinc-plated mild steel, stainless steel roller

Circuit diagram

DIAGRAM OF CONNECTIONS

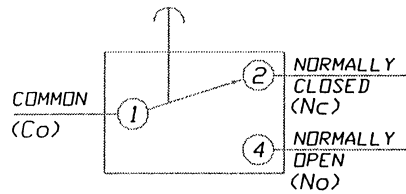

Dimensions

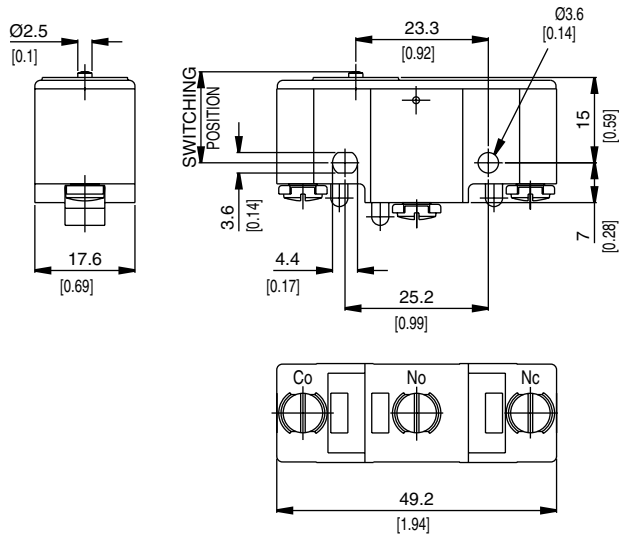

### Recommended maximum electrical ratings

Voltage (max)	Load (A)	Horsepower	Approval
250 VAC	15 (0.75 pf)	-	ULS 1054/CSA 22.2 No. 55 - 100,000 operations
125 VAC	15 (0.75 pf)	-	ULS 1054/CSA 22.2 No. 55 - 100,000 operations
250 VAC	-	½ HP	ULS 1054 - Horsepower - 6,000 operations
125 VAC	-	½ HP	ULS 1054 - Horsepower - 6,000 operations
0 - 15 VDC	15	-	General rating - 50,000 operations
15 - 30 VDC	10	-	General rating - 50,000 operations

Operating Characteristics

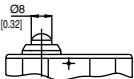
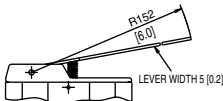
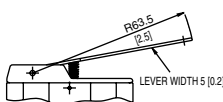
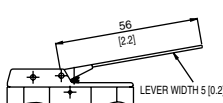
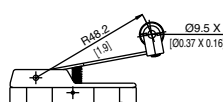
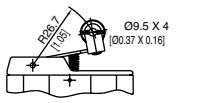
Actuator	Reference	Actuating Force Maximum		Release Force Minimum		Operating Position		Movement Differential Minimum		Over travel	
		(N)	(ozf)	(N)	(ozf)	(mm)	(in)	(mm)	(in)	(mm)	(in)
Plunger 	PN401	3,8	13,70	1,3	4,7	16,0 ± 0,4	0,63 ± 0,016	0,02	0,0008	0,2	0,008
Spring plunger 	PN4D2	3,8	13,70	1,3	4,7	22,2 ± 0,4	0,87 ± 0,016	0,04	0,0016	2,3	0,09
Plain lever 	PN4K152	0,3	1,08	0,1	0,36	25,5 ± 1,5	1,00 ± 0,060	3,0	0,12	10,0	0,39
Lever width: 5 mm. 0.2 in											
Plain lever 	PN4K63	0,9	3,20	0,1	0,36	19 ± 0,8	0,75 ± 0,032	1,2	0,047	5,6	0,22
Lever width: 5 mm. 0.2 in											
Reverse action plain lever 	PN4KZ56	1,5	5,40	0,5	1,80	8,5 ± 0,8	0,33 ± 0,032	1,0	0,004	6,0	0,24
Lever width: 5 mm. 0.2 in											
Roller lever 	PN4GK48	1,1	4,00	0,2	0,72	30,2 ± 0,8	1,19 ± 0,032	0,9	0,035	4,2	0,165
Roller lever 	PN4GK26	1,7	6,11	0,2	0,72	30,2 ± 0,8	1,19 ± 0,032	0,5	0,02	2,0	0,079

# PN4

## Operating Characteristics

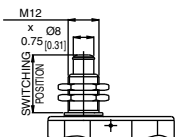
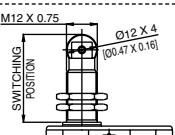
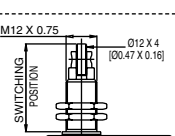
Actuator	Reference	Actuating Force		Release Force		Operating Position		Movement Differential		Over travel	
		Maximum (N)	(ozf)	Minimum (N)	(ozf)	(mm)	(in)	Minimum (mm)	(in)	(mm)	(in)
Long overtravel plunger	 PN41	3,8	13,70	1,3	4,7	21,8 ± 0,7	0,86 ± 0,028	0,04	0,0016	5,5	0,21
Spring plunger - in-line roller	 PN4G	3,8	13,70	1,3	4,7	33,3 ± 1,2	1,31 ± 0,047	0,04	0,0016	3,5	0,14
Spring plunger - across-line roller	 PN4GH	3,8	13,70	1,3	4,7	33,3 ± 1,2	1,31 ± 0,047	0,04	0,0016	3,5	0,14

## Ordering Reference

Type	PN4	
Actuators	01	Plunger
	D2	Spring plunger
	K152	Plain lever (length 152 mm, 6.0 in)
	K63	Plain lever (length 63.5 mm, 2.5 in)
	KZ56	Reverse action plain lever
	GK48	Roller lever (length 48 mm, 1.87 in)
	GK26	Roller lever (length 26.7 mm, 1.05 in)
	1	Long overtravel plunger
	G	Spring plunger, in-line roller
	GH	Spring plunger, across-line roller
Approvals	No digit	UL and cUL