

Think Automation and beyond...



HE2G Grip Switch



Compact, light-weight grip switch provides a comfortable hold

An HE2B enabling switch compliant with IEC/EN60947-5-8 is installed inside the HE2G grip switch.

**The world's
smallest and lightest
in its class!**



UL listing pending

Variation

Select from a wide variety of options

Equipped with different types of control units for various use.

• HE2G-21SHE-L-L
Emergency Stop Switch
XA1E-BV3U02R

A: Momentary Type Pushbutton (white)
AB6M-M2PLW
B: Momentary Type Pushbutton (white)
AB6M-M2PLW

• HE2G-21SHE-L-K
Emergency Stop Switch
XA1E-BV3U02R

A: Momentary Type Pushbutton (white)
AB6M-M2PLW
B: Key Selector
AS6M-2KT2PA

• HE2G-21SHE-P-0
Emergency Stop Switch
XA1E-BV3U02R

C: Pilot Light (green)
UP9P-2498G

Internal connector and solder terminals available

Wire-saving internal connectors and solder terminal connections can be selected

Internal Connector Type



Solder Terminal Type



Design

Compactly designed to fit comfortably in the hand

The curved grip and small-size of the grip switch makes operation comfortable. The light-weight (approx. 140g, HE2G-21SH) and compact size is suitable for operators with small hands and for use in narrow work areas.



Lighter operating force ensures stress-free operation

The operating force required to shift from position 1 (contact OFF) to position 2 (contact ON) is reduced by 50% from that of IDEC's HE1G grip switch. Less operating force ensures stress-free operation for long hours.

3-position switch with distinctive tactile feedback

A tactile clicking feedback allows easy recognition of switch operation when shifting from position 1 (contact OFF) to position 2 (contact ON).

Safety

Dual enabling contacts ensures high level of safety

The dual enabling contacts with a separate actuator for each contact is IDEC's original structure, which ensures higher level of safety. Disparity detection of a category 4 (ISO 13849-1) level can be achieved by using this switch with a safety relay module or a safety controller.

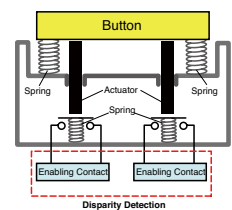

Actuators with plastic holders applicable for HS5 series miniature interlock switches can be used with HE2G

Example of automatic and manual operation modes when HS5B/HS5D is used



Automatic mode



Manual mode

Operation modes can be changed easily by inserting/removing the actuator with plastic holder installed to the HE2G into the HS5B/HS5D.

When the actuator is inserted, the operation is in automatic mode. When the actuator is removed, the operation is in manual mode.

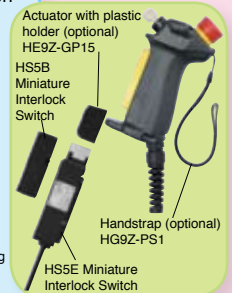

Types

3-Position Switch	Monitor Switch	Contact Configuration				Rubber Boot Material / Color	Wiring Style	Type No. (Ordering Type No.)	
		Emergency Stop Switch	Control Unit (A)	Control Unit (B)	Pilot Switch (green) (C)				
2 contacts	With (1NC)	Without				Silicon Rubber / (Yellow) (*2)	Solder Terminal	HE2G-21SH	
		Without					NBR/PVC Polyblend / (Gray) (*3)	Internal Connector	HE2G-21SC
		Without						Without	Solder Terminal
		Without					Without		Internal Connector
		With (2NC)	Without		Without	Silicon Rubber / (Yellow) (*2)		Solder Terminal	HE2G-21SHE
		Without	Without		With		Solder Terminal	HE2G-21SHE-P-0	
			Without		Without		Solder Terminal	HE2G-21SH-L-L	
		With (2NC)	Momentary Pushbutton (DPDT)	Without			Without	Solder Terminal	HE2G-21SHE-L-L
Without				Internal Connector	HE2G-21SCE-L-L				
Key Selector Switch (DPDT)	Without		Solder Terminal	HE2G-21SHE-L-K					
	Without		Internal Connector	HE2G-21SCE-L-K					

- *1) Additional control units installed on the HE2G are as follows:
Emergency Stop Switches: XA1E-BV3U02R
Momentary Pushbuttons: AB6M-M2PLW
Key Selector Switches: AS6M-2KT2PA Pilot Lights: UP9P-2498G
- *2) Silicon rubber: Can be used in general factories. Remains flexible at cold temperatures. Suitable in applications in a wide operating temperature range.
- *3) NBR/PVC polyblend: Oil-proof. Suitable for environments subjected to machine oil and painting robot where silicon rubber cannot be used.

Specifications

Degree of Protection (IEC 60529)	IP67, 66 (without additional control units) IP65 (with additional control units)	
Conditional Short-circuit current	50A (250V) (Note)	
Direct Opening Force	60N (monitor switch)	
Free Fall	1.0m 1 fall (IEC60068-2-32 compliant)	
Applicable Wire Size	Internal Connector	0.05 to 0.86 mm ² AWG18 to 30) (AWG22 between switch and connector)
	Solder Terminal	0.5 mm ² maximum
Applicable Cable	Multicore cable diameter ϕ 4.5 to 10 mm	

Note) Use 250V/10A fast-blow fuse as a short-circuit protector

Contact Ratings

Rated Insulation Voltage (Ui)	250V (momentary pushbutton and key selector: 125V) / 30V (pilot light)				
Rated Thermal Current (Ith)	3A (emergency stop switch: 5A)				
Rated Voltage (Ue)	30V	125V	250V		
Rated Current (Ie) 3-position switch (Terminal No. NO1-C1, NO2-C2)	AC	Resistive Load (AC-12)	—	1A	0.5V
		Inductive Load (AC-15)	—	0.7V	0.5V
	DC	Resistive Load (DC-12)	1A	0.2V	—
		Inductive Load (DC-13)	0.7V	0.1V	—

- Note) Minimum applicable load (reference value): 3V AC/DC, 5 mA (Applicable operation area depends on the operating conditions.)
*However, operating temperature for internal connectors:
-25°C min., 40°C max. 2.5A (12 to 19 poles), 2A (20 to 22 poles)
40°C min., 50°C max. 2.5A (8 to 12 poles), 2A (13 to 22 poles)
50°C min., 60°C max. 2.5A (6, 7 poles), 2A (8 to 13 poles), 1.5A (14 to 22 poles)

Operating Characteristics

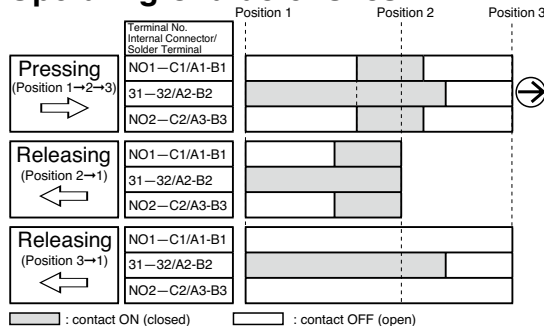

- Terminals NO1-C1/A1-B1, NO2-C2/A3-B3 are outputs of the 3-position enabling switch.
- The above operation characteristics show when the center of the grip switch button is pressed. Because two contacts are designed to operate independently, pressing the edge of the button turns on one contact earlier than the other contact, causing a delay in operation. To avoid this, always press the center of the button.

Specifications and other descriptions in this catalog are subject to change without notice.

Additional Control Unit Layout

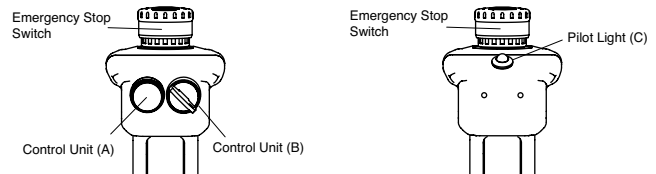

Contact Arrangement (Internal Connector)

Internal Connector Pin No.

4-pin 6-pin

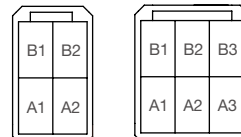

3-position switch/control unit side connector:
Tyco Electronics D-1200D Series
Tab housing: 1-1903130-2 (4-pin connector)
1-1903130-3 (6-pin connector)
Tab contact: 19303116-2

- Emergency stop switch
- 3-position switch
- Momentary pushbutton
- Key selector switch

Terminal Arrangement (TOP VIEW)

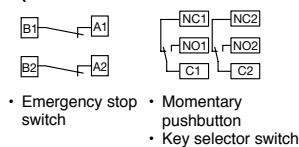

- For signal types of the 3-position switch, see "Operating Conditions".
- For solder terminal type terminal arrangement of each control unit, see each catalog.

6-Pin Connector Allotment Chart

Internal Connector Pin No.	Momentary pushbutton	Key selector switch
A1	C2	
A2	NO2	
A3	NC2	
B1	C1	
B2	NO1	
B3	NC1	

Dimensions

HE2G-21SH/HE2G-21SC

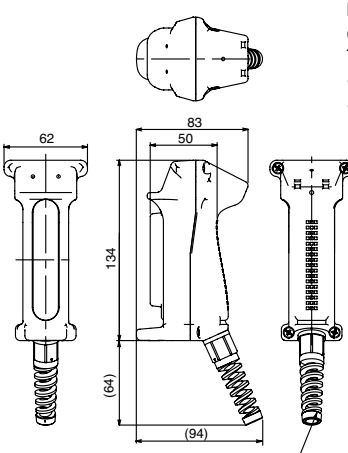

Cable Gland (supplied with grip switch)
Type No.: SKINTOP BS-M16 x 1.5 (LAPP)

All dimensions in mm.

Internal Connector

- Cable side connector:
Tyco Electronics D-1200D Series
- Receptacle: 1-1827864-□
 - Receptacle contact
1827586-2: AWG28 to 30 (Hand tool: 1762952-1)
1827587-2: AWG22 to 28 (Hand tool: 1762846-1)
1827588-2: AWG22 to 28 (Hand tool: 1762950-1)
1827589-2: AWG18 to 22 (Hand tool: 1762625-1)

Specify 2 or 3 in place of □.

- 2: 4-pin connector
- 3: 6-pin connector

The customer should purchase the connector.



IDEC CORPORATION

IDEC CORPORATION (USA)
IDEC CANADA LIMITED
IDEC AUSTRALIA PTY. LTD.
IDEC ELECTRONICS LIMITED

IDEC ELEKTROTECHNIK GmbH
IDEC (SHANGHAI) CORPORATION
IDEC (BEIJING) CORPORATION
IDEC (SHENZHEN) CORPORATION

IDEC IZUMI (H.K.) CO., LTD.
IDEC TAIWAN CORPORATION
IDEC IZUMI ASIA PTE. LTD.

7-31, Nishi-Miyahara 1-Chome, Yodogawa-ku, Osaka 532-8550, Japan
Tel: +81-6-6398-2571, Fax: +81-6-6392-9731
E-mail: marketing@idec.co.jp

www.idec.com