

Think Automation and beyond...



# PS5R-S

## Switching Power Supplies



IDEC CORPORATION

(07/09/18)

# The Slimmest Switching Power Supplies in Its

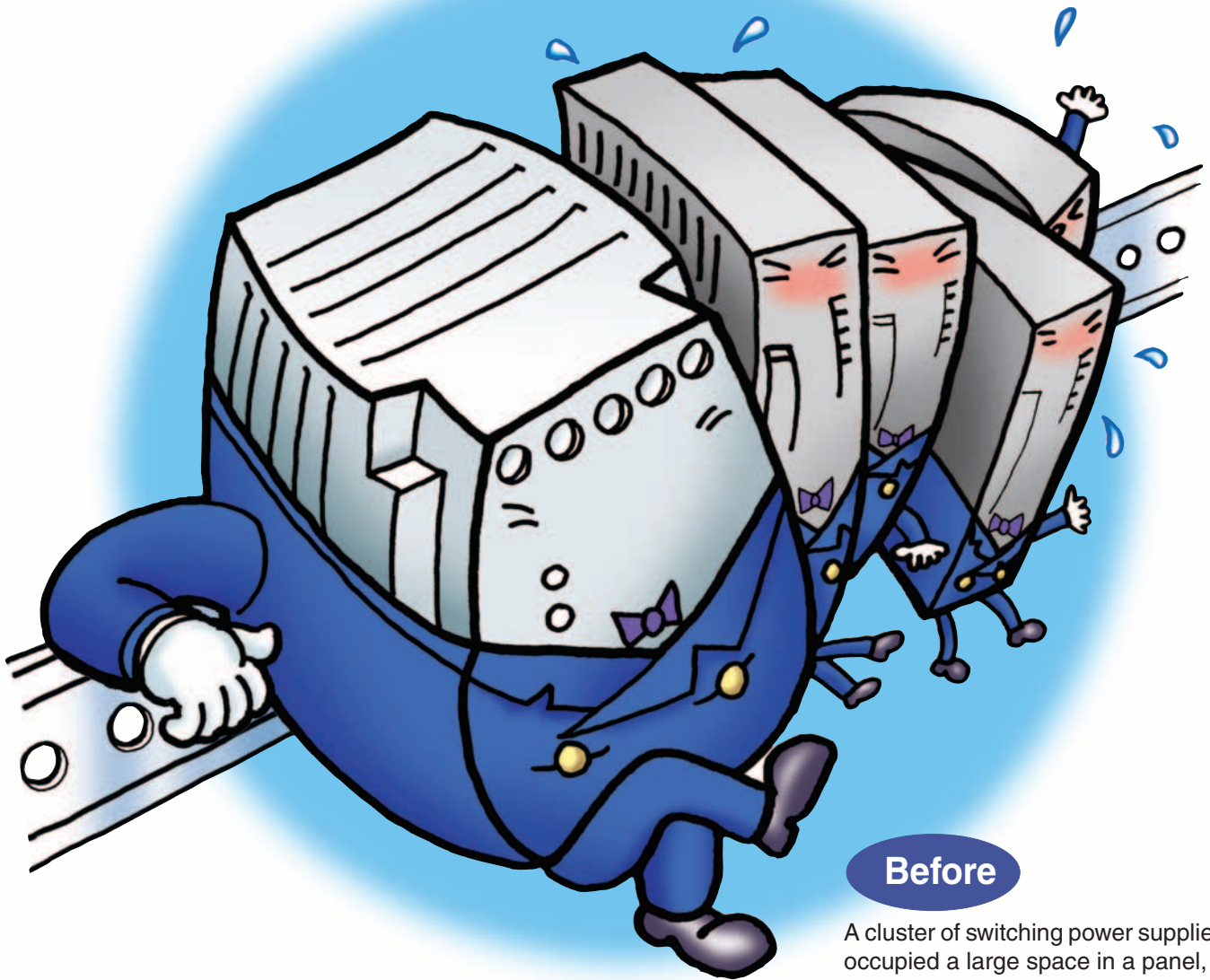

## Before

A cluster of switching power supplies occupied a large space in a panel, making it difficult to install other products.

Width: 22.5mm (10/15W), 36mm (30/60W), 46mm (90W), 50mm (120W), 80mm (240W)

Large capacity slim style.

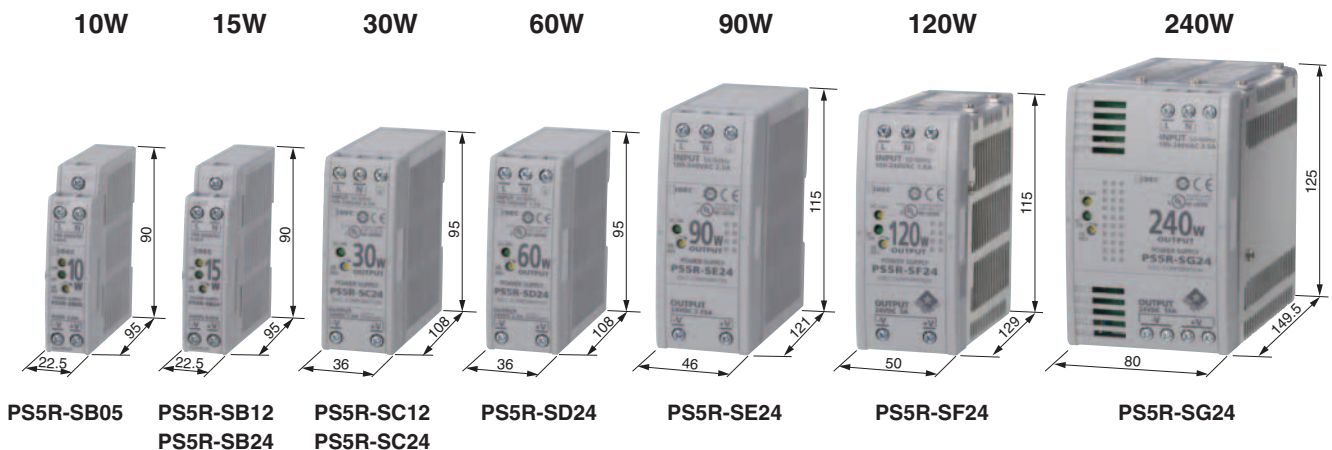

All dimensions in mm.

# Class Create More Space in Your Panel.

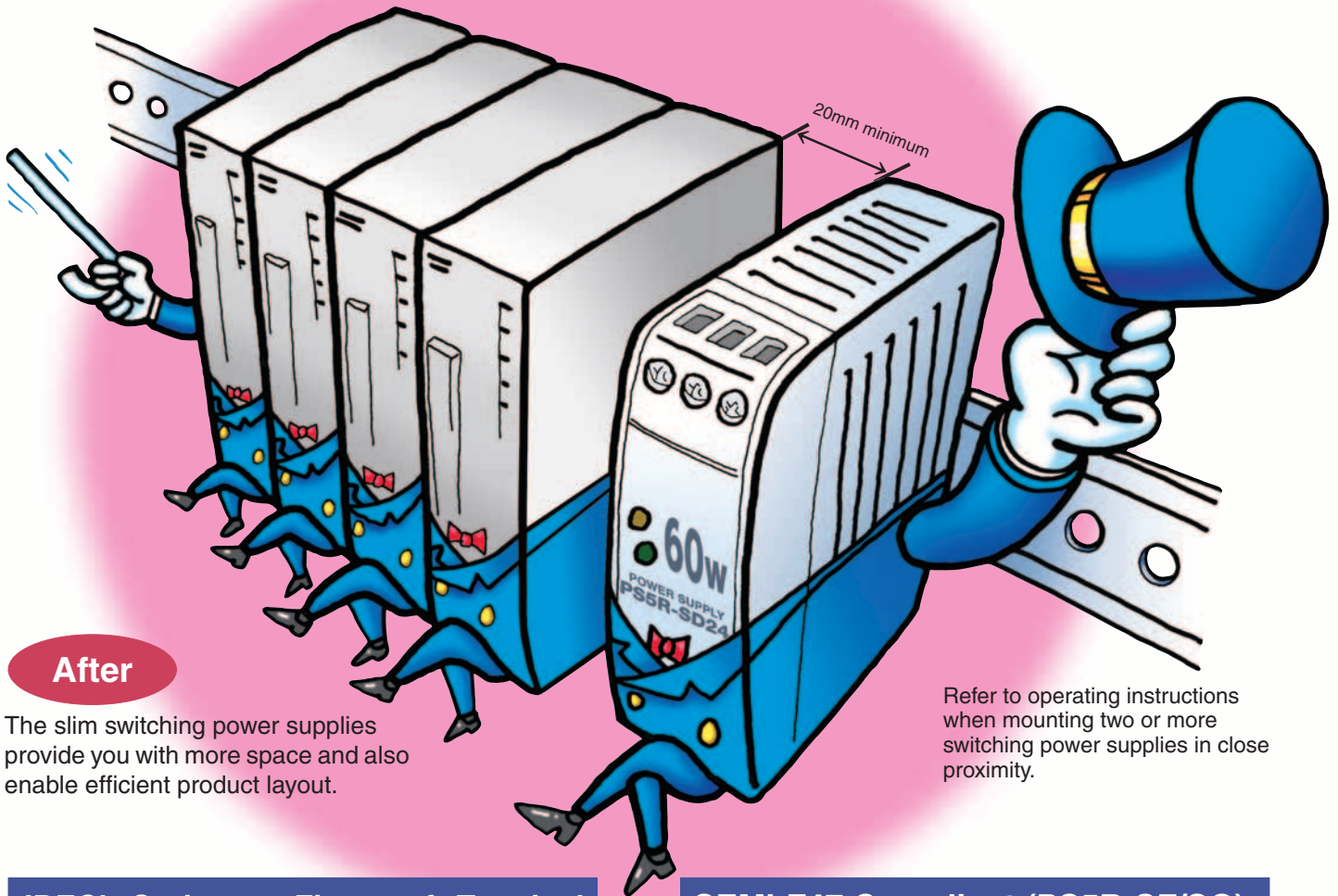

## After

The slim switching power supplies provide you with more space and also enable efficient product layout.

Refer to operating instructions when mounting two or more switching power supplies in close proximity.

## IDEC's Spring-up, Fingersafe Terminal

Spring-up, fingersafe terminals reduce wiring time and provide enhanced safety.

### Less wiring time

- Spring-up screws are captive, therefore screws will not be lost.
- Ring terminals can be connected.

### Finger-safe

- Terminals cannot be touched, preventing electric shocks.



## Separate Input and Output Terminals

Upper terminals: Input  
Lower terminals: Output

## Universal AC Voltage (100 to 240V AC)

## 3-Year Warranty

(07/09/18)

## SEMI-F47 Compliant (PS5R-SF/SG)

The PS5R-S switching power supplies are certified by EPRI PEAC, and "PQ Star" is marked on the product. SEMI-F47 "Specification for Semiconductor Processing Equipment Voltage Sag Immunity" defines voltage sag ride-through capability design requirements for semiconductor processing, metrology, and automated test equipment.



## Safety and High Quality

Compliant with UL1604, the PS5R-S switching power supplies can be used in hazardous locations—Class 1 Division 2, Groups A, B, C, and D.

UL508, UL1310 Class 2 (PS5R-SB/SC/SD), UL1604, CSA No. 14, No. 213, No. 223, EN 60950-1, EN50178, EN61204-3 (Class B) compliant.



## Panel Mounting Possible

The PS5R-S switching power supplies can be installed on a panel using a mounting bracket.



Installation Example

# PS5R-S Switching Power Supplies

## Slim size DIN rail mount switching power supplies with finger-safe terminals Universal input; Wide range 10W, 15W, 30W, 60W, 90W, 120W, and 240W

- Compact and light-weight  
Width: 22.5 mm (10W/15W), 36 mm (30W/60W), 46 mm (90W), 50 mm (120W), 80 mm (240W)
- Universal input:  
10W to 90W: 85-264V AC/100-370V DC  
120W and 240W: 85-264V AC/100-350V DC
- DIN rail mounting. Optional mounting bracket is available for panel mounting.
- IP20 fingersafe spring-up screw terminals
- CE marked (LVD and EMCD)
- EN61204-3 (DC power supply EMC Directive Class B)  
VCCI Class B compliant
- Meets SEMI F47 Sag Immunity (PS5R-SF/SG)
- Three-year Warranty



Approvals	Marking	Organization/ File No.
UL508 UL1604 UL1310 Class 2 (PS5R-SB/SC/SD) CSA C22.2 No. 14/213 CSA C22.2 No. 223 (PS5R-SB/SC/SD)		UL/c-UL File No. E234997
EN50178 EN60950-1		TÜV SÜD
EN50178 (LVD) EN60950-1 (LVD) EN61204-3 (EMCD)		EU LVD and EMCD
SEMI F47 (PS5R-SF/SG)		Semiconductor

### Types

Output Capacity	Type No.	Input Voltage	Output Voltage	Output Current	
10W	PS5R-SB05	100 to 240V AC (Voltage range: 85 to 264V AC 100 to 370V DC)	5V	2.0A	
15W	PS5R-SB12		12V	1.2A	
	PS5R-SB24		24V	0.65A	
30W	PS5R-SC12		12V	2.5A	
	PS5R-SC24		24V	1.3A	
60W	PS5R-SD24		24V	2.5A	
90W	PS5R-SE24		24V	3.75A	
120W	PS5R-SF24		100 to 240V AC (Voltage range: 85 to 264V AC 100 to 350V DC)	24V	5.0A
240W	PS5R-SG24		24V	10.0A	

### • DIN Rail

Appearance	Specifications	Type No.	Ordering Type No.	Package Quantity	Remarks
	Aluminum Weight: Approx. 200g	BAA1000	BAA1000PN10	10	Length: 1m Width: 35 mm
	Steel Weight: Approx. 320g	BAP1000	BAP1000PN10	10	

### • Mounting Clip

Appearance	Specifications	Type No.	Ordering Type No.	Package Quantity	Remarks
	Zinc-plated steel Weight: Approx. 15g	BNL5	BNL5PN10	10	Used on a DIN rail to prevent power supplies from sliding off the end.
		BNL6	BNL6PN10	10	

### • Panel Mounting Bracket

Applicable Switching Power Supply	Ordering Type No.	Package Quantity	Remarks
PS5R-SB	PS9Z-5R1B	1	For upright mounting
	PS9Z-5R2B	1	For flat mounting
PS5R-SC	PS9Z-5R1C	1	For upright mounting
PS5R-SD	PS9Z-5R1E	1	For upright mounting
PS5R-SF	PS9Z-5R1G	1	For upright mounting
PS5R-SG	PS9Z-5R1G	1	For upright mounting

### Type No. Development

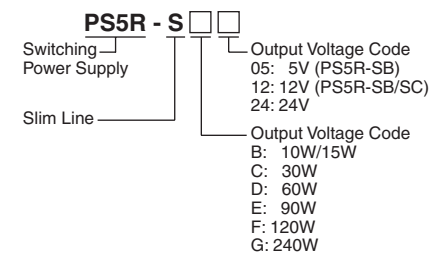

# PS5R-S Switching Power Supplies

## Specifications

Type		PS5R-SB05 (10W) PS5R-SB12 (15W) PS5R-SB24 (15W)	PS5R-SC12 PS5R-SC24 (30W)	PS5R-SD24 (60W)	PS5R-SE24 (90W)	PS5R-SF24 (120W)	PS5R-SG24 (240W)	
Input	Input Voltage (Single-phase two-wire) (Note 1)	100 to 240V AC (Voltage range: 85 to 264V AC/100 to 370V DC) (Duty ratio ≤ 80% at 100-105V DC)				100 to 240V AC (Voltage range: 85 to 264V AC/100 to 350V DC) (Duty ratio ≤ 80% at 100-110V DC)		
	Frequency	50/60 Hz						
	Input Current	100V AC	0.45A max.	0.9A max.	1.7A max.	2.3A max.	1.8A max.	3.5A max.
		200V AC	0.3A max.	0.6A max.	1.0A max.	1.4A max.	1.0A max.	1.7A max.
	Inrush Current	50A max. (Ta = 25°C, 200V AC cold start)						
	Leakage Current	132V AC	0.38 mA max.				0.5 mA max.	
		264V AC	0.75 mA max.				1.0 mA max.	
	Efficiency (Typical)	5V DC	69%	—	—	—	—	—
12V DC		75%	70%	—	—	—	—	
24V DC		79%	80%	83%	82%	84%	84%	
Power Factor (Typical)	100V AC	—	—	—	—	0.99	0.99	
	230V AC	—	—	—	—	0.90	0.92	
Output	Rated Voltage/Current	5V/2.0A (PS5R-SB05) 12V/1.2A (PS5R-SB12) 24V/0.65A (PS5R-SB24)	12V/2.5A (PS5R-SC12) 24V/1.3A (PS5R-SC24)	24V/2.5A	24V/3.75A	24V/5A	24V/10A	
	Adjustable Voltage Range	±10%						
	Output Holding Time	20 ms min.						
	Start Time	200 ms max.				650 ms max.	500 ms max.	
	Rise Time	100 ms max.				200 ms max.		
	Regulation	Input Fluctuation	0.4% max.					
		Load Fluctuation	1.5% max.					
		Temperature Change	0.05%/°C max. (-10 to +65°C)	0.05%/°C max. (-10 to +55°C)	0.05%/°C max. (-10 to +40°C)			
Ripple (including noise)		2% p-p max. (-10 to +65°C)	2% p-p max. (-10 to +55°C)	2% p-p max. (-10 to +40°C)		1% p-p max. (-10 to +40°C)		
Supplementary Functions	Overcurrent Protection	105% min. (auto reset)			103 to 110% (auto reset)	105 to 130% (auto reset)		
	Overvoltage Protection	Output off at 120% (Note 2)						
	Operation Indicator	LED (green)						
	Voltage Low Indication	LED (amber)	No				LED (amber)	
Dielectric Strength	Between input and output terminals: 3,000V AC, 1 minute Between input and ground terminals: 2,000V AC, 1 minute Between output and ground terminals: 500V AC, 1 minute							
Insulation Resistance	Between input and output terminals: 100MΩ min. (500V DC megger) Between input and ground terminals: 100MΩ min. (500V DC megger)							
Operating Temperature	-10 to +65°C (no freezing)		-10 to +60°C (no freezing, see the Output Derating Curves)					
Storage Temperature	-25 to +75°C (no freezing)							
Operating Humidity	20 to 90% RH (no condensation)							
Vibration Resistance	10 to 55 Hz, amplitude 0.375 m, 2 hours each in 3 axes							
Shock Resistance	300 m/s <sup>2</sup> (30G) (150 m/s <sup>2</sup> when using panel mounting bracket, except for PS5R-SB with 300 m/s <sup>2</sup> ), 3 shocks each in 6 axes							
EMC	EMI	EN61204-3 (Class B)						
	EMS	EN61204-3 (industrial)						
Applicable Standards	UL508 (Listing), UL1604, UL1310 Class 2 CSA C22.2 No. 14 CSA C22.2 No. 213 CSA C22.2 No. 223 EN50178, EN60950-1				UL508 (Listing), UL1604 CSA C22.2 No. 14 CSA C22.2 No. 213, EN50178, EN60950-1			
Other Standard	—					SEMI F47		
Dimensions (mm)	90H × 22.5W × 90D	95H × 36W × 108D		115H × 46W × 121D	115H × 50W × 129D	125H × 80W × 149.5D		
Weight (approx.)	160g	250g	285g	440g	630g	1000g		
Terminal Screw	M3.5 slotted-Phillips head screw							

Note 1: DC input voltage is not subjected to safety standards. The input voltage range approved by safety standards is 100 to 240V AC. When using on DC input, connect a fuse to the input terminal for DC input protection.

Note 2: One minute after the output has been turned off, turn on the input again.

## Reference Value

Expected Life	8 years minimum (at the rated input, duty ratio 50%, operating temperature +40°C, standard mounting direction)
---------------	--

Calculation of the expected life is based on the life of the aluminum electrolytic capacitor. The expected life is subjected to operating conditions.

# PS5R-S Switching Power Supplies

## Block Diagrams

### • PS5R-SB/SC

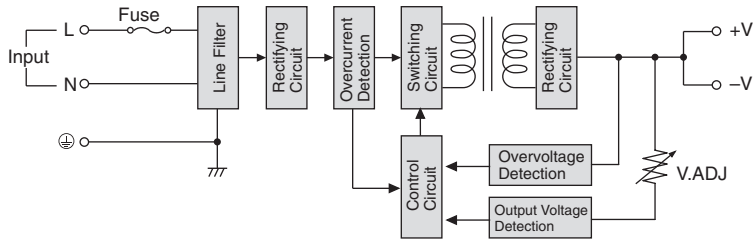

### • PS5R-SD/SE

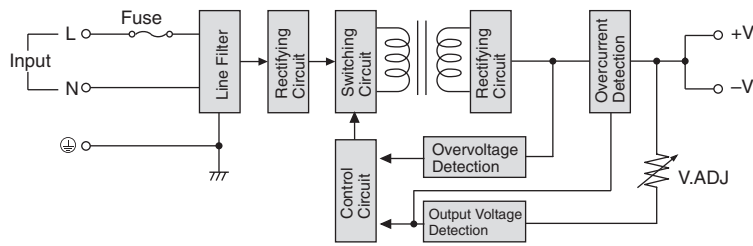

### • PS5R-SF/SG

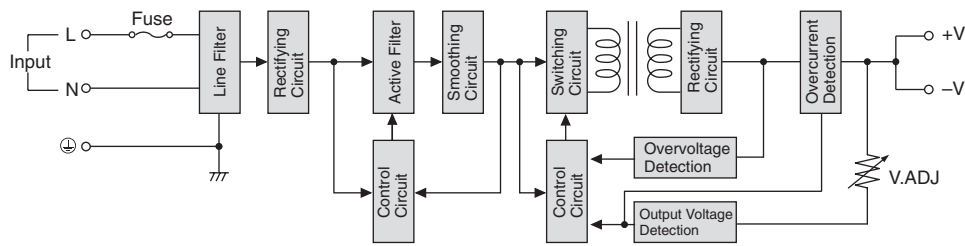

## Characteristics

### • Operating Temperature vs. Output Current (Derating Curves)

Conditions: Natural air cooling

**PS5R-SB**

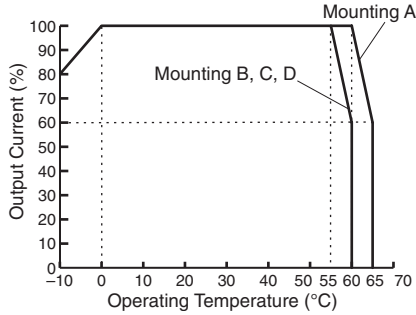

**PS5R-SC**

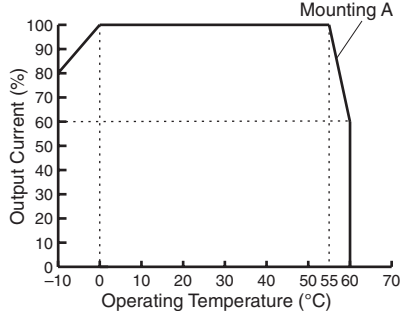

**PS5R-SD/SE/SF**

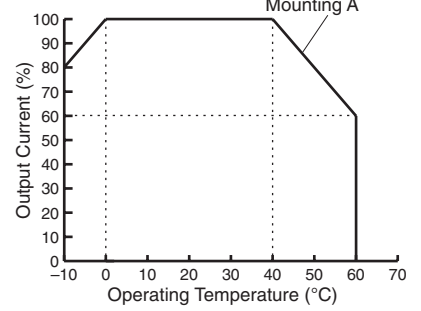

**PS5R-SG**

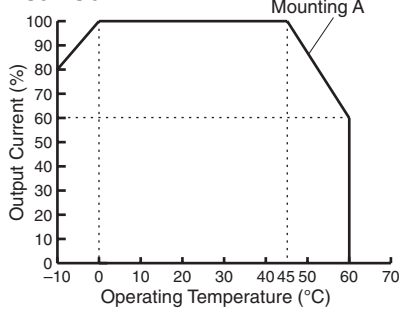

### • Operating Temperature Approved by Safety Standards UL 508, EN 60950-1, and EN 50178

Type No.	UL 508		EN 60950-1, EN 50178	
	Mounting A	Mounting B, C, and D	Mounting A	Mounting B, C, and D
PS5R-SB05, -SB12, -SB24	55	55	60	55
PS5R-SC12, -SC24	55	Impossible	55	Impossible
PS5R-SD24, -SE24, -SF24	40	Impossible	55	Impossible
PS5R-SG24	45	Impossible	55	Impossible

### • Mounting Style

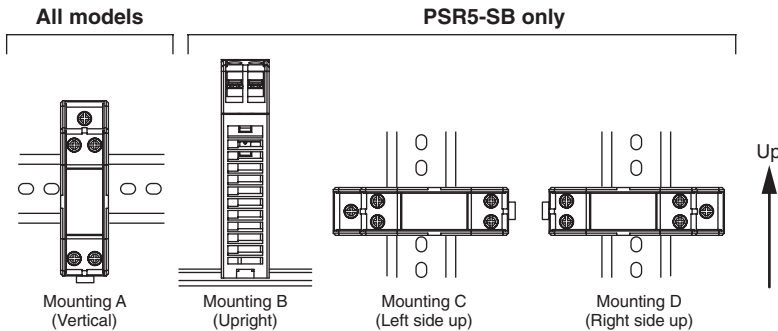

### • Overcurrent Protection Characteristics

**PS5R-SB**

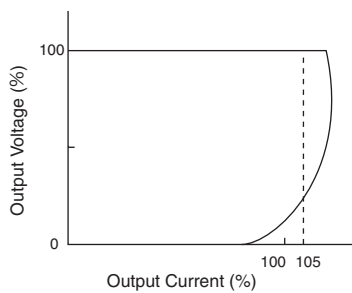

**PS5R-SC**

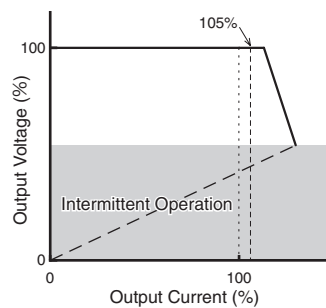

**PS5R-SD**

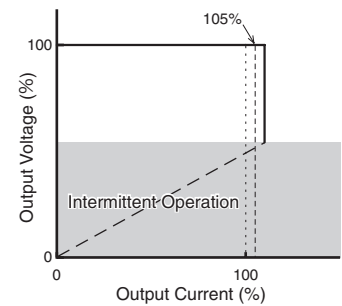

**PS5R-SE**

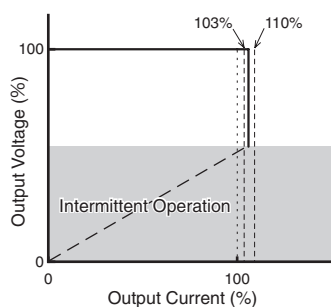

**PS5R-SF/SG**

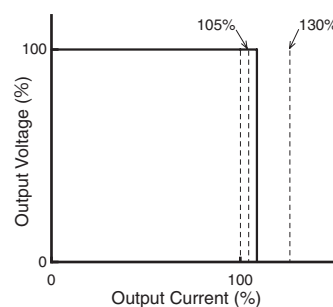

# PS5R-S Switching Power Supplies

## Dimensions

### • PS5R-SB

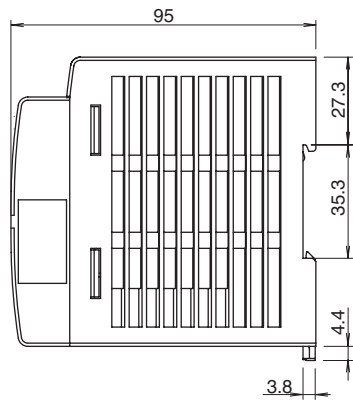
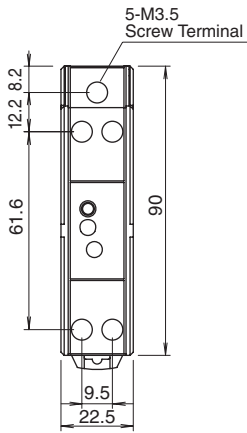

**PS9Z-5R1B**  
Panel Mounting Bracket

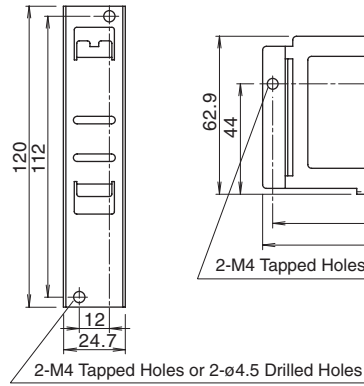

**PS9Z-5R2B**  
Panel Mounting Bracket

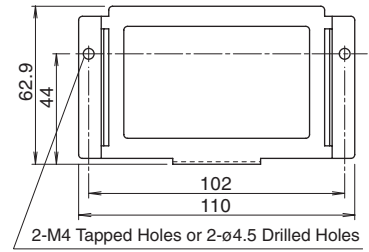

### • PS5R-SC/SD

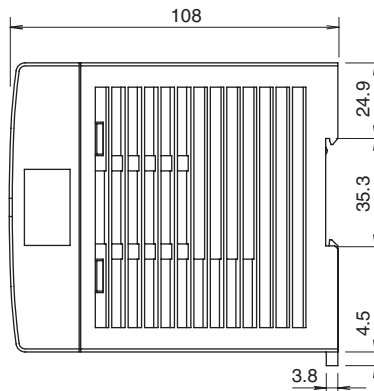
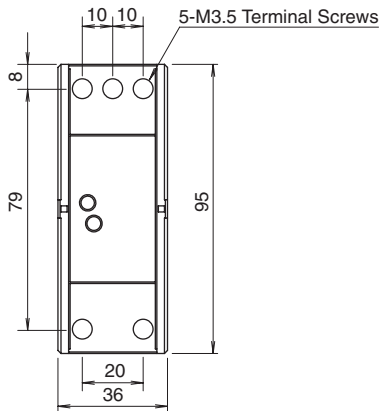

**PS9Z-5R1C**  
Panel Mounting Bracket

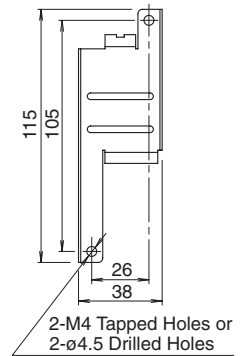

### • PS5R-SE

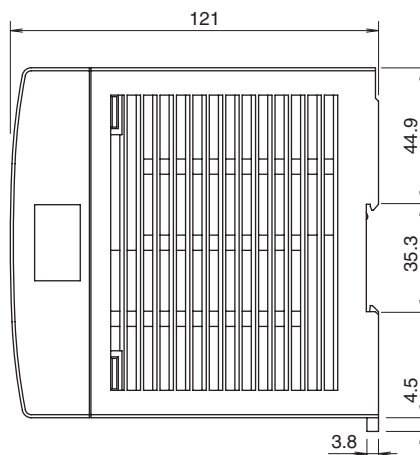
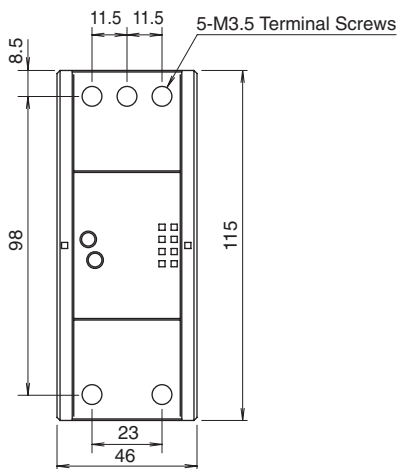

**PS9Z-5R1E**  
Panel Mounting Bracket

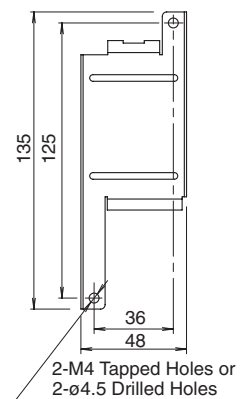

All dimensions in mm.

# PS5R-S Switching Power Supplies

## • PS5R-SF

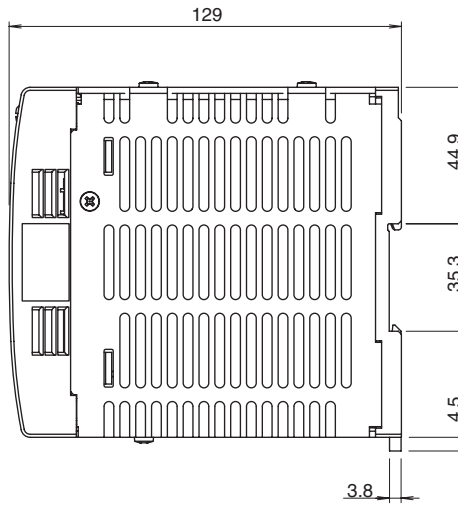
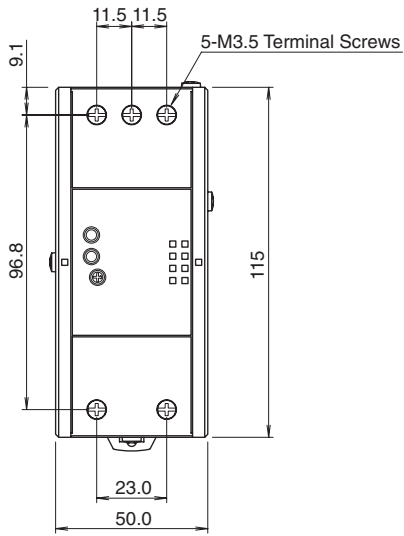

**PS9Z-5R1G  
Panel Mounting Bracket**

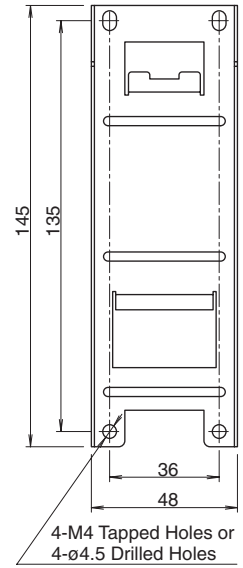

## • PS5R-SG

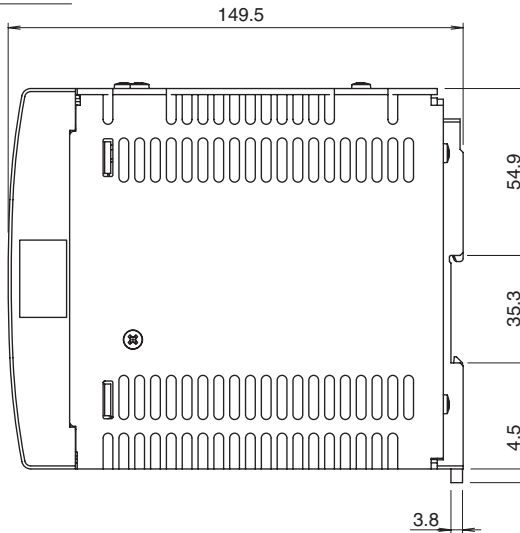
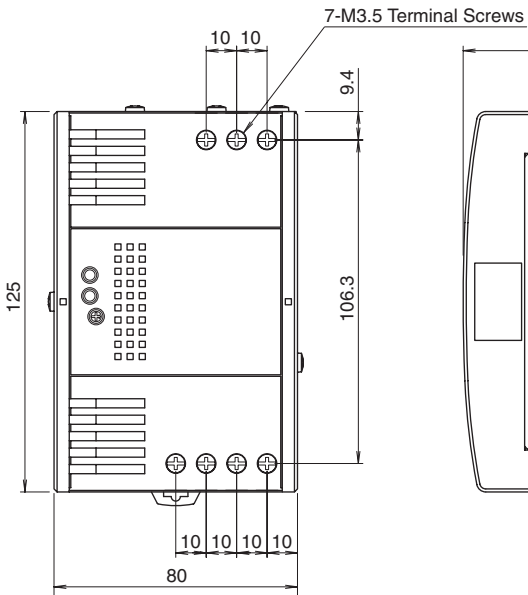

**PS9Z-5R1G  
Panel Mounting Bracket**

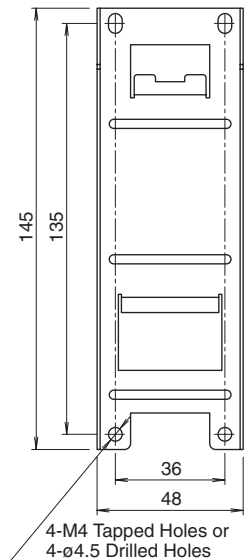

All dimensions in mm.

# PS5R-S Switching Power Supplies

## Parts Description

### • PS5R-SB

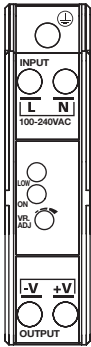

### • PS5R-SC/SD/SE

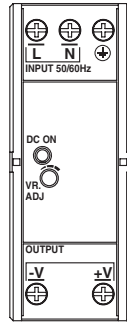

### • PS5R-SF/SG

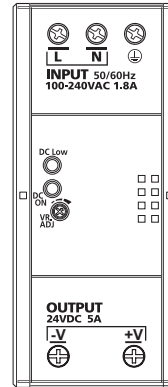

Marking	Name	Description
VR.ADJ	Output Voltage Adjustment	<ul style="list-style-type: none"> <li>Allows adjustment within <math>\pm 10\%</math>. Turning clockwise increases the output voltage.</li> </ul>
DC ON	Operation Indicator (Green)	<ul style="list-style-type: none"> <li>Lights when the output voltage is on.</li> </ul>
DC Low	Output Low Indicator (Amber)	<ul style="list-style-type: none"> <li>Lights when the output voltage drops below approx. 80% of the rated value (PS5R-SB/SF/SG only).</li> </ul>
+V -V	DC Output Terminals	<ul style="list-style-type: none"> <li>+V: Positive output terminal</li> <li>-V: Negative output terminal</li> </ul>
⊕	Ground Terminal	<ul style="list-style-type: none"> <li>Be sure to connect this terminal to a proper ground.</li> </ul>
L N	Input Terminal	<ul style="list-style-type: none"> <li>Accepts a wide range of voltage and frequency. Polarity does not matter when using DC input.</li> </ul>

### • DC ON and DC Low Indicators

When the output voltage drops below approx. 80% of the rated value, the DC Low LED goes on.

The status can be seen by the DC ON and DC Low indicators.

Status	Normal	Overload or Input Voltage Low*	Output Short-circuit	Output OFF
DC ON LED (Green)	ON	ON	OFF	OFF
DC Low LED (Amber)	OFF	ON	ON	OFF

\* The LEDs go on when the input voltage drops below 57V AC at full load.

## Safety Precautions

- Do not use switching power supplies with electric equipment whose malfunction or inadvertent operation may damage the human body or life directly.
- Make sure that the input voltage and output current do not exceed the ratings. If the input voltage and output current exceed the ratings, electric shock, fire, or malfunction may occur.
- Do not touch the terminals of the switching power supply while input voltage is applied, otherwise electric shock may occur.
- Provide the final product with protection against malfunction or damage that may be caused by malfunction of the switching power supply.
- Operating temperatures should not exceed the ratings. Be sure to note the derating characteristics. If the operating temperature exceeds the ratings, electric shock, fire, or malfunction may occur.
- Blown fuses indicate that the internal circuits are damaged. Contact IDEC for repair. Do not just replace the fuse and reoperate, otherwise electric shock, fire, or malfunction may occur.
- Do not use the switching power supplies to charge rechargeable batteries.
- Do not overload or short-circuit the switching power supply for a long period of time, otherwise the internal elements may be damaged.
- Do not disassemble, repair, or modify the power supplies, otherwise the high voltage internal part may cause electric shock, fire, or malfunction.
- The fuse inside the PS5R-S switching power supply is for AC input. Use DC fuse for DC input.

## Instructions

### • Notes for Installation

1. When mounting the PS5R-S switching power supply, be sure to prevent heat built-up around the PS5R-S, taking the following precautions into consideration.

(1) Do not close the top and bottom openings of the PS5R-S.

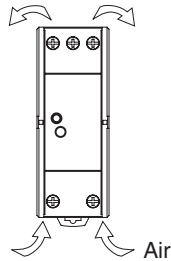

(2) Maintain a minimum of 20 mm clearance around the PS5R-S, except for the top and bottom openings.

(3) When derating of the output does not work, provide forced air-cooling.

(4) For wiring, use wires with heat resistance of 60°C or higher.

(5) Recommended tightening torque of the input and output terminals is 0.8 N·m (UL listed torque value). Do not tighten to 1.8 N·m or higher.

(6) Use copper core wires of the following sizes.

Recommended wire size: AWG14 to 18  
(cross section: 0.9 to 2 mm<sup>2</sup>)

2. When mounting multiple PS5R-S switching power supplies side by side, maintain a minimum of 20 mm clearance. Observe the derating curves in consideration of the ambient temperature.

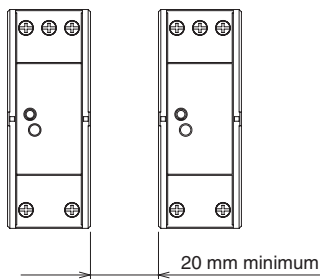

3. Mounting on 35-mm-wide DIN rails

### Mounting

Fasten the DIN rail to a mounting plate using screws firmly.

When mounting the PS5R-S on a DIN rail, place the PS5R-S as shown. With the clamp inserted, press the PS5R-S towards the DIN rail.

### Removal

Insert a flat screwdriver into the slot in the clamp, and pull out the clamp until it clicks. Turn the PS5R-S bottom out.

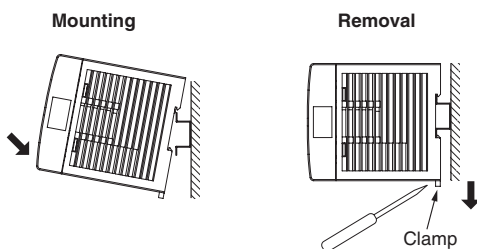

4. Installing the Panel Mounting Bracket

### <Installing PS9Z-5R1 Panel Mounting Bracket>

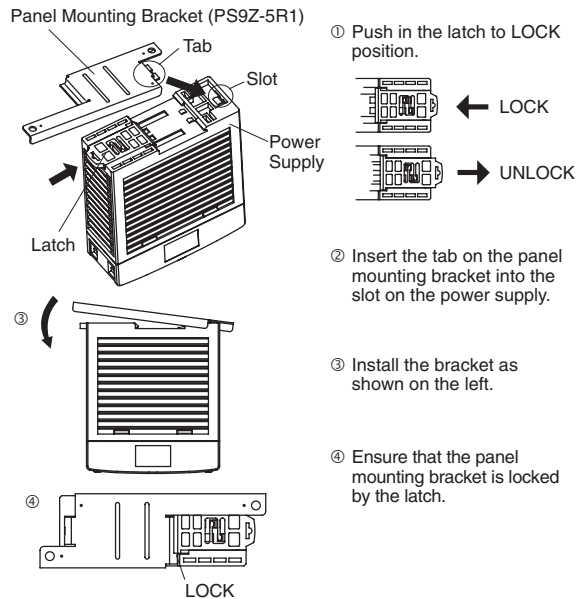

### <Installing PS9Z-5R2B Panel Mounting Bracket>

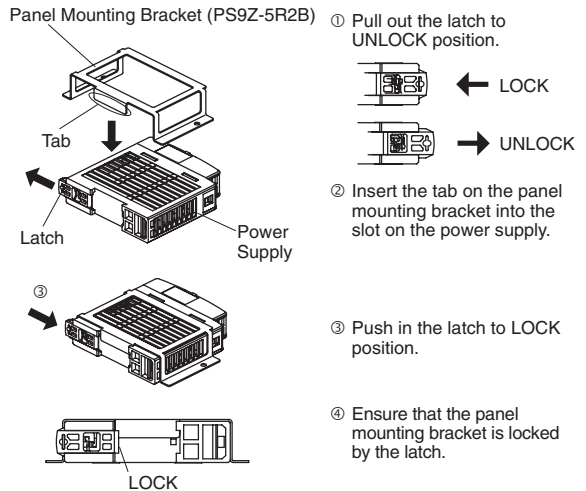

### • Adjustment of Output Voltage

The output voltage can be adjusted within  $\pm 10\%$  of the rated output voltage by using the VR.ADJ control on the front. Turning the VR.ADJ clockwise increases the output voltage. When using a higher output voltage, reduce the output current to make sure that the output capacity is within the rating. Note that overvoltage protection may work when increasing the output voltage.

### • Overcurrent Protection

The output voltage drops automatically when an overcurrent flows due to an overload or short circuit. Normal voltage is automatically restored when the load returns to normal conditions.

### • Overvoltage Protection (OVP)

The output is turned off by overvoltage protection when an overvoltage is applied to the input. When the output voltage has dropped due to an overvoltage, turn the input off, and after one minute, turn the input on again.

# PS5R-S Switching Power Supplies

## • Insulation/Dielectric Test

When performing an insulation/dielectric test, short-circuit the input (between L and N) and output (between +V and -V). Do not apply or interrupt the voltage quickly, otherwise surge voltages may be generated and the PS5R-S may be damaged.

## • Series Operation

The following series operation is allowed. (When UL1310 Class 2 is applied, series operation is not allowed.)

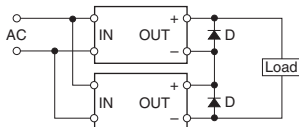

Connect Schottky diodes D as shown above. Select Schottky diodes in consideration of the rated current.

## • Parallel Operation

Parallel operation is not possible to increase the output capacity, because the internal elements and load may be damaged. Redundant operation is possible using the following connection.

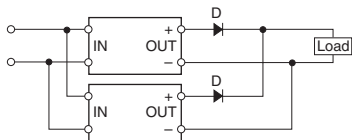

## • Redundant Operation

Redundant operation is a connection method of two switching power supplies in parallel for emergency. Normally one switching power supply has a sufficient output. If one switching power supply fails, another one operates to continue the output. Make sure that the sum of power consumption by load and diode is not greater than the rated wattage (rated voltage × rated current) of one switching power supply.

## • Notes for Operation

1. Output interruption may indicate blown fuses. Contact IDEC.
2. The PS5R-S switching power supply contains an internal fuse for AC input. When using with DC input, install an external fuse for DC input. To avoid blown fuses, select a fuse in consideration of the rated current of the internal fuse.

## Rated Current of Internal Fuses

Type No.	Internal Fuse Rated Current
PS5R-SB	2A
PS5R-SC, PS5R-SD	3.15A
PS5R-SE, PS5R-SF	4A
PS5R-SG	6.3A

3. Avoid overload and short-circuit for a long period of time, otherwise the internal elements may be damaged.
4. DC input operation is not subject to safety standards.

## • Rust and Scratches on Housing, Frame, and Metal Parts

Bonded steel plates and hot-dip galvanized steel plates are used for the PS5R-S switching power supplies, and may develop scratches on the surface or rust on the edge depending on the storage condition.

## Ordering Information

- When ordering, specify the Type No. and quantity.

## Warranty

### • Period

IDEC warrants the PS5R-S switching power supply for a period of three years from the date of shipment.

### • Scope

IDEC agrees to free repair or replacement of the PS5R-S switching power supply if the product has been operated under the following conditions.

1. Average operating temperature (ambient temperature of switching power supply) is 40°C at maximum.
2. Average load factor is 80% at maximum.
3. Input voltage is the rated input voltage.
4. Standard mounting style

- IDEC shall not be liable for other damages including consequential, contingent or incidental damages.

Warranty does not apply if the PS5R-S switching power supply was subject to:

1. Inappropriate handling, or operation beyond the specifications.
2. Modification or repair by other than IDEC.
3. Failure caused by other than the PS5R-S switching power supply.
4. Failure caused by natural disasters.

Specifications and other descriptions in this catalog are subject to change without notice.



## IDEC CORPORATION

7-31, Nishi-Miyahara 1-Chome, Yodogawa-ku, Osaka 532-8550, Japan  
Tel: +81-6-6398-2571, Fax: +81-6-6392-9731  
E-mail: products@idec.co.jp

**IDEC CORPORATION (USA)**  
1175 Elko Drive, Sunnyvale, CA 94089-2209, USA  
Tel: +1-408-747-0550 / (800) 262-IDEAC (4332)  
Fax: +1-408-744-9055 / (800) 635-6246  
E-mail: opencontact@idec.com

**IDEC CANADA LIMITED**  
Unit 22-151, Brunel Road, Mississauga, Ontario,  
L4Z 1X3, Canada  
Tel: +1-905-890-8561, Toll Free: (888) 317-4332  
Fax: +1-905-890-8562  
E-mail: sales@ca.idec.com

**IDEC AUSTRALIA PTY. LTD.**  
2/3 Macro Court, Rowville, Victoria 3178, Australia  
Tel: +61-3-9763-3244, Toll Free: 1800-68-4332  
Fax: +61-3-9763-3255  
E-mail: sales@au.idec.com

**IDEC ELECTRONICS LIMITED**  
Unit 2, Beechwood, Chineham Business Park,  
Basingstoke, Hampshire RG24 8WA, UK  
Tel: +44-1256-321000, Fax: +44-1256-327755  
E-mail: sales@uk.idec.com

**IDEC ELEKTROTECHNIK GmbH**  
Wendenstrasse 331, 20537 Hamburg, Germany  
Tel: +49-40-25 30 54 - 0, Fax: +49-40-25 30 54 - 24  
E-mail: service@idec.de

**IDEC (SHANGHAI) CORPORATION**  
Room 608-609, 6F, Gangtai Plaza, No. 700,  
Yan'an East Road, Shanghai 200001, PRC  
Tel: +86-21-5353-1000, Fax: +86-21-5353-1263  
E-mail: idec@cn.idec.com

**IDEC (BEIJING) CORPORATION**  
Room 211B, Tower B, The Grand Pacific Building,  
8A Guanghua Road, Chaoyang District,  
Beijing 100026, PRC  
Tel: +86-10-6581-6131, Fax: +86-10-6581-5119

**IDEC (SHENZHEN) CORPORATION**  
Unit AB-3B2, Tian Xiang Building, Tian'an Cyber Park,  
Fu Tian District, Shenzhen, Guang Dong 518040, PRC  
Tel: +86-755-8356-2977, Fax: +86-755-8356-2944

**IDEC IZUMI (H.K.) CO., LTD.**  
Units 11-15, Level 27, Tower 1,  
Millennium City 1, 388 Kwun Tong Road,  
Kwun Tong, Kowloon, Hong Kong  
Tel: +852-2803-8989, Fax: +852-2565-0171  
E-mail: info@hk.idec.com

**IDEC TAIWAN CORPORATION**  
8F-1, No. 79, Hsin Tai Wu Road, Sec. 1,  
Hsi-Chih, Taipei County, Taiwan  
Tel: +886-2-2698-3929, Fax: +886-2-2698-3931  
E-mail: service@tw.idec.com

**IDEC IZUMI ASIA PTE. LTD.**  
No. 31, Tannery Lane #05-01,  
HB Centre 2, Singapore 347788  
Tel: +65-6746-1155, Fax: +65-6844-5995  
E-mail: info@sg.idec.com